

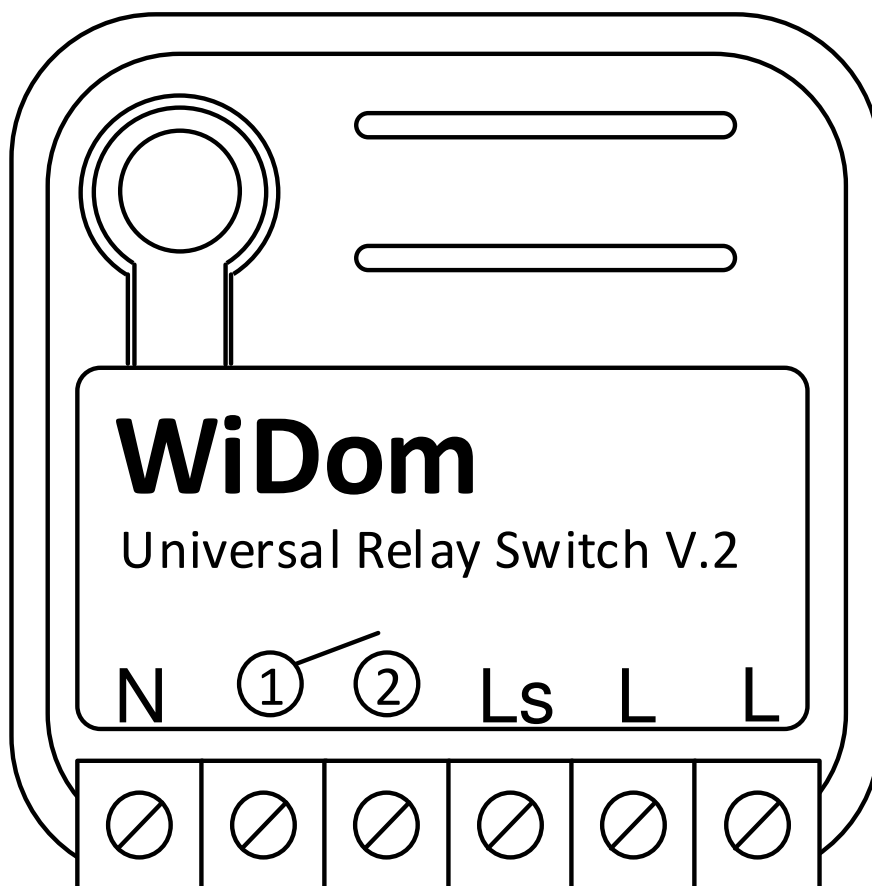

UNIVERSAL RELAY SWITCH V2



UBS v.2 Operating instructions

Revision History

| Rev. Doc. | Date | Revisor | Pag. | Description |
|-----------|------------|---------|------|-----------------|
| 1 | 25/02/2016 | RC | all | Initial Version |

Device description

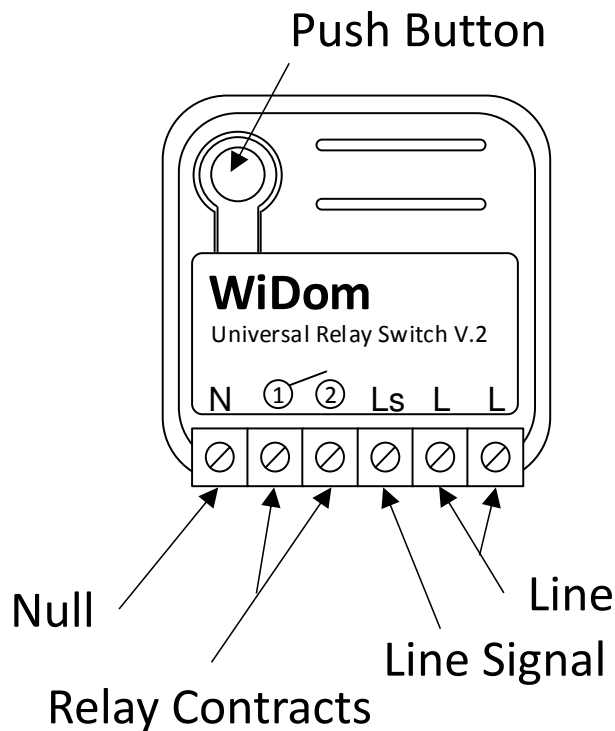

| | |
|----------------|---|
| Line | Phase connection terminals |
| Null | Neutral connection terminal |
| Relay Contacts | Latching Relay Contacts |
| Line signal | This terminal gets a phase signal that drives the relay. The system recognises the status change of this connection (switch from 0 to phase voltage and vice versa) |
| Push Button | Service button: 1 or 3 clicks enters Learning Mode, with 6 clicks the system is reset to factory settings |

Technical Specification

| | |
|-------------------------------|--|
| Power supply | 230 VAC±10% 50/60 Hz |
| Maximum Load | 2500 VA – 250 VAC - 10A resistive load in AC 300 VA – 30 VDC – 10A resistive load in DC |
| System temperature limitation | 105 °C |
| Work temperature | 0 – 40° C |
| Radio protocol | Z-Wave 868,4 MHz |
| Range | up to 60 m outdoors, up to 30 m indoors |
| Dimensions (HxWxD) | 37x37x17 mm |
| Consumption | < 230 mW |
| Actuator element | Latching relay |
| Conformity | CE, RoHs |
| Electrical IP Rating | IP20 |

Introduction

WiDom Universal Relay Switch is a Z-Wave certified “in wall device”.

The device is based on the use of a latching relay that is combined with an innovative design and effective implementation to ensure extremely low energy consumption.

WiDom Universal Relay Switch is designed for being installed in junction boxes, flush mount boxes and near lights. WiDom Universal Relay Switch is an ON\OFF device and can be used as both a local and remote switch.

At the same time, it is completely configurable so that it can adapt to the most varied needs while also being ready to be used without needing additional configurations in order to operate.

Thanks to the framework developed by WiDom, the various types of “events” on the “External Switch” can be recognised and associated to actions to be performed on the device, and\or on any associated devices and\or on all devices on the network. The events that the system recognises are the number of “clicks” or hold on the External Switch.

Although Z-Wave is quite new technology, it has already become recognizable and officially binding standard, similarly to Wi-Fi. Many manufacturers in various industries offer solutions based on Z-Wave technology, guaranteeing their compatibility. This means that the system is open and it may be extended in the future.



External Switch: Any switch, button or traditional wall control connected to the device in order to turn it on or off.



Events: The actions performed on the external Switch: Clicks or Hold.



Click: If the external switch is a button (when pressed it returns to the start position by itself), a click means pressing and then releasing it. If the external switch is a bistable one (after being pressed it does not return to the original position), a single click means one single flip of the switch.





Hold: This applies only to buttons that are normally open and that are identified as such when the pressure phase lasts at least 1,5 seconds.





Device in **ON\OFF** status refers to the fact that the latching relay contact is in the Open\Close position.

Installation

 **WARNING:** WiDom Universal Relay Switch must be installed by a certified electrician in compliance with the safety requirements set forth in national law regulations.

 **DANGER:** WiDom Universal Relay Switch must be connected to 240VAC. Before performing any installation operations, make sure the main switch on the meter is set to **OFF**.

 **DANGER:** Any procedure that calls for the use of the service button (B) is related only to the installation phase and is to be considered a service procedure that must be performed by qualified personnel. This operation must be performed with all necessary precautions for operating in areas with a single level of insulation.

 **WARNING:** Do not connect loads that exceed the maximum load permitted by the relay contacts. In the case of greater loads, WiDom Universal Relay Switch may be used to control an external relay or a contactor. For non-resistive loads, the maximum load must be appropriately reduced.

 **WARNING:** All connections must be performed according to the electrical diagrams provided

WiDom Universal Relay Switch Activation

- 1) Make sure the mains switch is set to the **OFF** position
- 2) Connect the device based on the diagrams provided
- 3) Close the electrical box that contains the device
- 4) Turn the system back on
- 5) Include the device in the Z-Wave network

 **TIP:** The antenna must not be shortened, removed or modified. To ensure maximum efficiency, it must be installed as shown. Metal equipment near the antenna can negatively affect reception. Each WiDom device is a node in a mesh network. If there are metal obstacles, the obstacle can often be overcome with a further triangulation node.

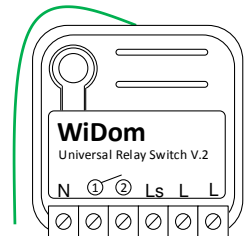

Electrical connections

The device must be supplied by phase and neutral. The third control wire carries a phase signal on the **Ls** terminal controlled by the external switch.

Diagram A

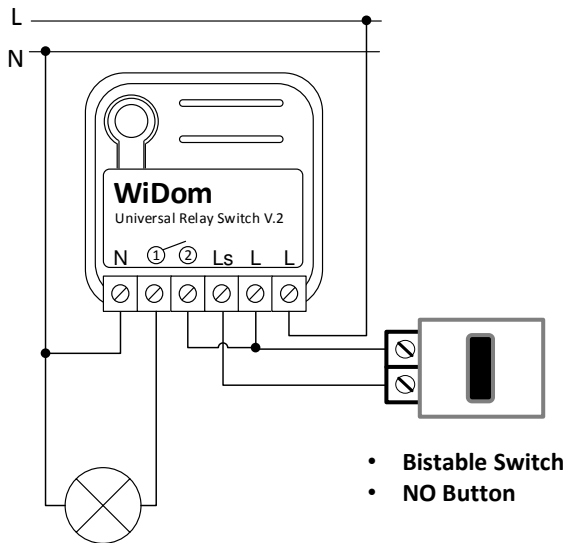

N) Neutral; L) Phase; 1 and 2) Relay contacts; Ls) Control contact

Diagram B

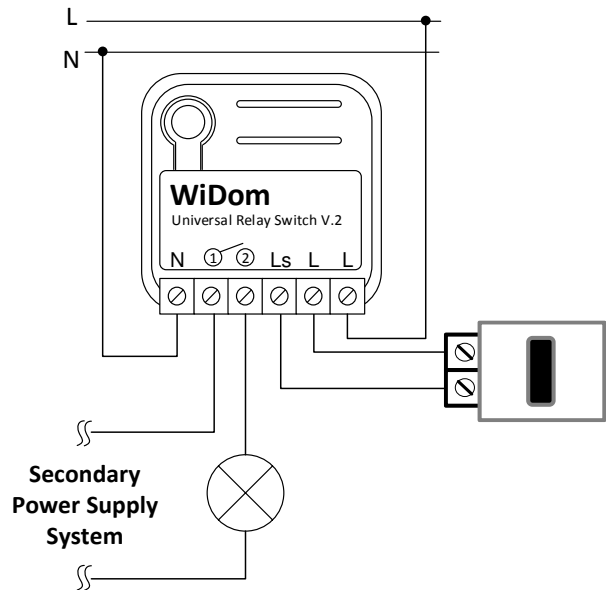

N) Neutral; L) Phase; 1 and 2) Relay contacts; Ls) Control contact

*Maximum wire length < 15m

i **INFO:** The external switch can be either a bistable, a normally opened button or any sequence of SPDT - DPDT (Fig.AB.1) or buttons (Fig.AB.2).

Fig.AB.1

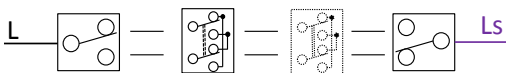
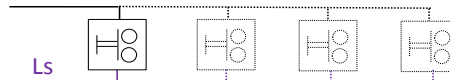

Fig.AB.2



i **INFO:** If using a secondary load supply system, it must be connected as in diagram B. The supply voltage can be either AC or DC within the limits permitted by the relay contact, up to 250 V in AC and up to 30 V in DC.

! **WARNING:** The line connected to the relay contacts must be suitably protected from short circuits and overloads connected to a possible failure of the connected load

Reset to the factory settings

The device can be reset to the original factory settings using one of the following methods:

Method 1: Remove the device from the Z-Wave network

Method 2: Six consecutive clicks on service button (B)

Method 3: Set parameter 61 to value 0 - FACTORY RESET (see paragraph 0).



INFO: If the reset is performed while the device is still part of a network, it notifies the other devices that it has been removed (*Device Reset Locally Notification*). If WiDom Universal Relay Switch receives a removal notification from another device, it will delete the removed device from its own associations.

Including the device into an existing Z-Wave network

WiDom Universal Relay Switch can be included and operated in any Z-Wave network with other Z-Wave certified devices from any other manufacturers. As constantly powered node WiDom Universal Relay Switch will act as repeater regardless of the vendor in order to increase reliability of the network.

The device supports both the *Network Wide Inclusion* mechanism (which offers the ability to be included in a network even if the device is not in the direct range of the controller) and *Normal Inclusion*.

By default, if the device is not included in any network, as soon as it is powered the *Network Wide Inclusion* procedure starts and lasts for about 1 minute.

If the used controller does not support the *Network Wide Inclusion* functionality, the device may be included in the network through *Normal Inclusion* by pressing the service button (B) once or three times or alternatively by pressing the external switch once.



INFO: During the inclusion procedure activated by a single click on the external switch, the system also automatically determines the switch type (See parameter No. 62).

Excluding the device from a Z-Wave network

Only a controller can remove a device from the network. WiDom Universal Relay Switch is compatible with all Z-Wave certified controllers. After the exclusion function has been activated from the controller, the device can be removed, putting it in *Learning Mode* by pressing the service button (B) once or three times or more conveniently by using the external switch after having enabled the learning mode activation from external switch (see parameter N°65).

Request network update

If there is a **SUC** (Static Update Controller) or **SIS** (SUC ID Server) in the network, a network update can be requested by pressing the external switch four times.

Associations

WiDom Universal Relay Switch can control other devices like other relays or dimmers. WiDom Universal Relay Switch supports 5 association groups:

Group 1: devices that will be notified of changes in its status

Group 2: devices that will be controlled by a single click on the external switch

Group 3: devices that will be controlled by a double click on the external switch

Group 4: devices that will be controlled by a triple click on the external switch

Group 5: devices that will be controlled by hold on the external switch



TIP: WiDom Universal Relay Switch can control up to 16 devices for each group. To avoid network delays, we recommend limiting the amount of associated devices to no more than 5 per group.

Controlling the device with an external switch

With WiDom devices, the normal switches/buttons found in a traditional electrical system can become intelligent control systems.

WiDom Framework recognises the number of clicks or hold event on the external switch and can be configured to perform different actions based on the identified event.

Controlling the device via the Z-Wave network

All Z-Wave controllers can control the device using the *Basic Set* command.

The behaviour of the device based on its status and on the commands received from the network can also be configured.

Alarms management

WiDom Universal Relay Switch can also be configured to react to alarm notifications from sensors on the network. WiDom Universal Relay Switch recognises and complies with *Notification V3 Report frame* alarm notifications.



INFO: By default, WiDom Universal Relay Switch reacts to smoke, heat, water and home security alarms generated by others Z-Wave sensors in the system. The reaction type: **ON**, **OFF** or **FLASHING** can be configured as needed.

Switch ALL ON\OFF

By default, WiDom Universal Relay Switch accepts *Switch All ON\OFF* commands.

Timer option

WiDom Universal Relay Switch has a built-in configurable timer for programmed switch-off.

Configurations

Controlling the device by external switch

Clicks on the external switch turn the connected load on or off depending on the initial status, on the number of clicks and on the device configuration. The actions that will be performed on the associated devices and on all other devices on the network can also be configured.



INFO: As soon as the click recognition process has completed, the device will be set to the desired status, any *switch all on\off* actions will be performed and the associated devices will be controlled.

Device status

The final device status will be determined by the initial status, number of clicks or hold. The following configurations can be used to configure parameters 1 through 4.

| Value | Initial status | Final status |
|------------|----------------|---|
| 1 – TOGGLE | ON | OFF |
| | OFF | ON |
| 2 – ON | ON | If the initial status is OFF , the system will switch ON ; otherwise, it maintains its status (ON). |
| | OFF | |
| 3 – OFF | ON | If the initial status is ON , the system will switch OFF ; otherwise, it maintains its status (OFF). |
| | OFF | |
| 4 – IGNORE | ON | The device maintains its initial status and if the programmed switch-off timer is active, it is restarted. |
| | OFF | |

Parameter No. 1: Device status when the external switch receives 1 click (1 byte).

Default value: **1 – TOGGLE**

Parameter No. 2: Device status when the external switch receives 2 clicks (1 byte).

Default value: **1 – TOGGLE**

Parameter No. 3: Device status when the external switch receives 3 clicks (1 byte).

Default value: **1 – TOGGLE**

Parameter No. 4: Device status when the external switch is held down (1 byte) - This parameter only takes effect if a normally open button is connected.

Default value: **1 – TOGGLE**



WARNING: Careless usage of the configuration parameters can create inconsistencies.

Controlling the associated devices

The actions performed on associated devices in terms of **Basic Set** will be determined by the initial status, number of clicks or hold. The following configurations can be used to configure parameters 5 through 8.

| Configuration | Initial device status | Action performed on the associated device |
|---------------------------------|-----------------------|---|
| 1 – TOGGLE | ON | Basic Set OFF_LEVEL |
| | OFF | Basic Set ON_LEVEL |
| 2 – IGNORE IF ON | ON | No action |
| | OFF | Basic Set ON_LEVEL |
| 3 – IGNORE IF OFF | ON | Basic Set OFF_LEVEL |
| | OFF | No action |
| 4 – TOGGLE ASSOCIATED | ON | The status of each associated device is requested with the Basic Get command. If it is OFF , the Basic Set ON command is sent, otherwise the Basic Set OFF command is sent. |
| | OFF | |
| 5 – SET AS INITIAL STATUS VALUE | ON | Basic Set ON_LEVEL |
| | OFF | Basic Set OFF_LEVEL |
| 6 – IGNORE | ON | No action |
| | OFF | |



TIP: TOGGLE ASSOCIATED: This configuration is useful for configuring the device as a remote switch. We recommend this configuration for controlling a single remote device. When using this option, in order to avoid any inconsistent result, we recommend keeping the **Switch All** actions disabled.

Parameter No. 5: Action on the associated devices when the external switch receives 1 click (1 byte).

Default value: **1 – TOGGLE**

Parameter No. 6: Action on the associated devices when the external switch receives 2 clicks (1 byte).

Default value: **1 – TOGGLE**

Parameter No. 7: Action on the associated devices when the external switch receives 3 clicks (1 byte).

Default value: **6 – IGNORE**

Parameter No. 8: Action on the associated devices when the external switch is held down (1 byte).

Default value: **1 – TOGGLE**

Switch ALL functionality

The actions performed on all network devices in terms of **Switch ALL** will be determined by the initial status, number of clicks or hold. If there are associated devices and there are control actions set for these devices, the Switch ALL actions are performed first.

The following configurations can be used to configure parameters 9 through 12.

| Value | Initial device status | Action performed on all devices in the network |
|---------------------------------|-----------------------|--|
| 1 – TOGGLE | ON | SWITCH ALL OFF |
| | OFF | SWITCH ALL ON |
| 2 – IGNORE IF ON | ON | No action |
| | OFF | SWITCH ALL ON |
| 3 – IGNORE IF OFF | ON | SWITCH ALL OFF |
| | OFF | No action |
| 4 – SET AS INITIAL STATUS VALUE | ON | SWITCH ALL ON |
| | OFF | SWITCH ALL OFF |
| 5 – IGNORE | ON | No action |
| | OFF | |

Parameter No. 9: Action performed on all network devices when the external switch receives 1 click (1 byte).

Default value: **5 – IGNORE**

Parameter No. 10 (0xA): Action performed on all network devices when the external switch receives 2 clicks (1 byte). Default value: **5 – IGNORE**

Parameter No. 11 (0xB): Action performed on all network devices when the external switch receives 3 clicks (1 byte). Default value: **5 – IGNORE**

Parameter No. 12 (0xC): Action performed on all network devices when the external switch is held down (1 byte). Default value: **5 – IGNORE**

Controlling the device by Z-Wave Network

The device final status reached by the device when it receives a **Basic Set** command from the Z-Wave network.

Parameter No. 20 (0x14): Device status upon receipt of a Basic Set (1 byte)

| Value | Command received | Final status |
|--|------------------|--|
| 1 – HOW RECEIVED (Default value) | ON | ON |
| | OFF | OFF |
| 2 – IGNORE IF ON | ON | Maintains the initial status |
| | OFF | OFF |
| 3 – IGNORE IF OFF | ON | ON |
| | OFF | Maintains the initial status |
| 4 - IGNORE | ON | Maintains the initial status and, if the programmed switch-off timer is active, it is restarted. |
| | OFF | |

Setting ON LEVEL and OFF LEVEL

Defines the values associated to the ON_LEVEL and OFF_LEVEL parameters used in the **Basic Set** commands. The following values can be used to configure parameters 30 through 37.

From: 1 to 99 for dimming purpose – 0 (OFF) and 255(0xFF) (ON) for switching ON/OFF

Parameter No. 30 (0x1E): ON_LEVEL value used for devices belonging to Group 2 (1 Click association group) (1 byte).

Default value **255(0xFF) – ON**

Parameter No. 31 (0x1F): OFF_LEVEL value used for devices belonging to Group 2 (1 Click association group) (1 byte).

Default value **0 – OFF**

Parameter No. 32 (0x20): ON_LEVEL value used for devices belonging to Group 3 (2 Click association group) (1 byte).

Default value **255(0xFF) – ON**

Parameter No. 33 (0x21): OFF_LEVEL value used for devices belonging to Group 3 (2 Click association group) (1 byte).

Default value **0 – OFF**

Parameter No. 34 (0x22): ON_LEVEL value used for devices belonging to Group 4 (3 Click association group) (1 byte).

Default value **255(0xFF) – ON**

Parameter No. 35 (0x23): OFF_LEVEL value used for devices belonging to Group 4 (3 Click association group) (1 byte).

Default value **0 – OFF**

Parameter No. 36 (0x24): ON_LEVEL value used for devices belonging to Group 5 (Hold association group) (1 byte).

Default value **255(0xFF) – ON**

Parameter No. 37 (0x25): OFF_LEVEL value used for devices belonging to Group 5 (Hold association group) (1 byte).

Default value **0 – OFF**

Timer Option

Enabling the timer for relay switch-off

The switch-off timer can be associated with any click or hold event. When the timer is enabled for the specific event that generated the **ON** status, the device will go into the **OFF** status after the period of time defined in parameter No. 45. The following configuration values can be used for parameters 40 through 44.

0 – TIMER DISABLED

1 – TIMER ENABLED

Parameter No. 40 (0x28): Timer associated with the 1 click event on the external switch (1 byte) - Enables the switch-off timer if the device switches to **ON** following a single click on the external switch.

Default value: **0 – TIMER DISABLED**

Parameter No. 41 (0x29): Timer associated with the 2 click event on the external switch (1 byte) - Enables the switch-off timer if the device switches to **ON** following a double click on the external switch.

Default value: **0 – TIMER DISABLED**

Parameter No. 42 (0x2A): Timer associated with the 3 click event on the external switch (1 byte) - Enables the switch-off timer if the device switches to **ON** following a triple click on the external switch.

Default value: **0 – TIMER DISABLED**

Parameter No. 43 (0x2B): Timer associated with the hold event on the external switch (1 byte) - Enables the switch-off timer if the device switches to **ON** following hold on the external switch. Default value: **0 – TIMER DISABLED**

Parameter No. 44 (0x2C): Timer associated with the reception of a Basic Set command (1 byte) - Enables the switch-off timer if the device switches to **ON** following reception of a single click *Basic Set* command.

Default value: **0 – TIMER DISABLED**

Parameter No. 45 (0x2D): Switch-off timer (2 bytes) Defines the amount of time before the switch-off timer takes place Time in seconds (1 – 3600);

Default value **600 (0x258)**, 10 minutes.

Parameter No. 46 (0x2E): Switch-off timer validity (1 byte) - Defines the system behaviour if an event requests a status change for the device and the timer for the programmed switch-off timer was started by a previous event.

| Configuration | Device reaction |
|--------------------------------------|---|
| 0 - CANCEL | The switch-off timer is cancelled and the device maintains the last status reached. If the new status is ON and the event that generated it is associated with the timer, it is restarted. |
| 1 - MAINTAIN Default value | The switch-off timer is maintained |

Manage Alarms

WiDom devices can react to alarms received. The system recognises alarm messages (*version 3 of Alarm Command Class*). By default, all alarms are ignored except for those defined in the following table:

| Alarm | Alarm or Notification Type | Event | Event Parameters |
|----------------------|----------------------------|-------|------------------|
| Smoke Alarm, CO, CO2 | 0x01 – 0x02 – 0x03 | ANY | ANY |
| Heat Alarm | 0x04 | ANY | ANY |
| Water Alarm | 0x05 | ANY | ANY |
| Home Security | 0x07 | ANY | ANY |

The way the device reacts when it receives an alarm can be customised using parameters 50 through 53.

| Configuration | Device reaction |
|---------------|---|
| 1 – ON | The device status switches to ON |
| 2 – OFF | The device status switches to OFF |
| 3 – FLASH | The device switches from ON to OFF with a frequency and duration that can be customised using parameters 54, 55 and 56. |
| 4- IGNORE | The alarm will be ignored |

Parameter No. 50 (0x32): Smoke Alarm, CO, CO2 Action (1 byte) - Defines how the device reacts when it receives one of the following types of alarms: smoke, CO or CO₂.

Default value: **1 – ON**

Parameter No. 51(0x33): Heat Alarm (1 byte) - Defines how the device reacts when it receives Heat Alarm.

Default value: **1 – ON**

Parameter No. 52(0x34): Water Alarm (1 byte) - Defines how the device reacts when it receives Water Alarm.

Default value: **2 – OFF**

Parameter No. 53 (0x35): Home Security (1 byte) - Defines how the device reacts when it receives Home Security alarm.

Default value: **3 – FLASH**

Parameter No. 54 (0x36): ON time during flashing (1 byte) - Defines the number of seconds for the **ON** status during flashing - (from 1 to 255).

Default value: **5 seconds**

Parameter No. 55 (0x37): OFF time during flashing (1 byte) - Defines the number of seconds for the **OFF** status during flashing - (from 1 to 255).

Default value: **5 seconds**

Parameter No. 56 (0x38): Duration of flashing phase (1 byte) - Defines the time in minutes from the last receipt of the last alarm message received - (from 1 to 255).

Default value: **10 minutes**

Other configuration parameters

Parameter No. 60 (0x3C): Startup status (1 byte) - Defines the status of the device after a restart following a reset or black out.

| Configuration | Device reaction |
|---|---------------------------|
| 1 – ON | Device ON |
| 2 – OFF | Device OFF |
| 3 – PREVIOUS STATUS (Default value) | Status before the restart |

Parameter No. 61 (0x3D): Configuration reset (1 byte) Defines which parameters must be reset to defaults.

| Configuration | Device reaction |
|--------------------------------------|--|
| 0 – FACTORY RESET | The device is reset to the original factory settings. |
| 1 – ASSOCIATIONS RESET | All associations and only the associations are reset |
| 2 –CONFIGURATIONS RESET | The associations are maintained while all of the other configuration parameters are reset to the original factory settings except for this specific configuration. |
| 4 – IGNORE (Default value) | No action is performed |

Parameter No. 62 (0x3E): Type of external switch (1 byte) - Defines the type of external switch connected to the device.

| Configuration | Device reaction |
|---|--|
| 0 – IGNORE | The actions on the external switch are ignored. In this mode, the device can only be controlled via the network. |
| 1 – BUTTON | The external switch is a normally open button |
| 2 – BISTABLE SWITCH | The external switch is a traditional switch |
| 4 – AUTOMATIC RECOGNITION (Default value) | After the first single click on the external switch, the system automatically determines the type of external switch used and accordingly sets the parameter with the new value. |

Parameter No. 64 (0x40): Load protection (2 bytes) Defines the minimum amount of time in which the switch cannot be flipped twice in succession. Time in seconds (1 – 3600).

Default value: 0



INFO: Some types of loads require a rest period between switch-off and subsequent switch-on. This parameter is for setting this time. If this parameter is set and the load is off, when the device receives a switch-on command, it will be performed as soon as the protection time has been reached.

Parameter No. 65 (0x41): Learn Mode (1 byte) - This defines the sequence of clicks on the external switch to associate to *Learning Mode*.

| Configuration | Device reaction |
|--|--|
| 0 – DISABLED (Default value) | <i>Learning mode</i> cannot be activated from the external switch |
| 1 – 1 CLICK | <i>Learning mode</i> is activated by 1 click on the external switch |
| 2 – 2 CLICKS | <i>Learning mode</i> is activated by 2 clicks on the external switch |
| 3 – 3 CLICKS | <i>Learning mode</i> is activated by 3 clicks on the external switch |



INFO: When Learning mode is associated to a click event any configurations related to the associated devices and Switch All commands related to the same event are ignored. After the learning mode has been associated to a click event this configuration is honoured for a single event. After that event the Learning mode parameter will be reset to the default value (0 – DISABLED).

Disposing the devices

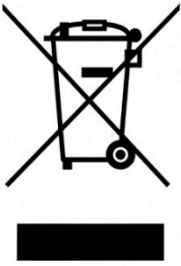

This product bears the selective sorting symbol for waste electrical and electronic equipment (WEEE).

This means that this product must be handled pursuant to European Directive 2002/96/EC in order to be recycled or dismantled to minimize its impact on the environment.

For further information, please contact your local or regional authorities.

Electronic products not included in the selective sorting process are potentially dangerous for the environment and human health due to the presence of hazardous substances.

Compliance with directives

WiDom devices are built in compliance with directives LVD 2006/95/EC, EMC 2004/108/CE and R&TTE

WiDom shall not be held responsible for any damage caused by these devices if they are used in a manner that is not compliant with the instructions in this manual. WiDom reserves the right to make any changes to the product that it considers necessary or useful without jeopardising its primary features.

Warranty

This warranty is provided by WiDom srl (hereinafter “WiDom”) based in Quartu S.Elena 09045 (CA), Italy (VAT number 03452490927).

WiDom warrants to the original purchaser (hereinafter “Customer”) that the device sold under this agreement (hereinafter “Device”) is free from defects in parts and workmanship under normal use for 12 months from date of purchase (“Warranty Period”).

The original purchase invoice or sales receipt, showing the date of purchase is the proof of date of purchase by the Customer.

If a Device, sold by WiDom to the Customer, has manufacturing defects or in any case of alleged lack of conformity, the Customer shall send within thirty (30) days from the day in which he discovers such defects, a claim form by using our web site: (www.widom.it) informing WiDom on the full name of the Customer, the nature of the defects and the date in which the Devices has been purchased.

Warranty Claims received after the expiration of the Warranty Period shall not be considered valid.

Once WiDom, receives the Warranty Claim, it shall inform the Customer by e-mail or letter, if the Warranty is applicable and the address where the Device shall be sent in order to verify the defects (if any). Customer must prepay shipping and transportation charges as indicated by WiDom. The Device shall be sent by the Customer to WiDom at its own costs and expenses, by express courier or hand delivered, and with the original packaging, the supplied accessories (if any) and documents proving date of purchase. WiDom shall then inform the Customer about the defects and on its repair or replacement (where applicable). Should WiDom not evidence defects on the Device, the Device shall be returned to the Customer.

Should WiDom notices the defects, and this warranty is applicable, it will remove, at its sole discretion, any defect, free of charge, by repairing any defective components of the Device with new or regenerated components or by replacing the Device. The Warranty Period of the replaced or repaired Device shall not be extended.

WiDom will ship the repaired or a replaced Device to Customer freight prepaid.

WiDom will not be liable for damages to property caused by faulty device. WiDom will not be liable for indirect, incidental, special, consequential or punitive damages, or for any damage, including, inter alia, loss of profits, savings, data, loss of benefits, claims by third parties and any property damage or personal injuries arising from or related to the use of the Device.

If the Device cannot be replaced with another of the same type (e.g. the Device is no longer in production or no longer available for selling in the Customer’s country), it may be replaced with a different one having similar technical specifications to the faulty one. Such replacement shall be considered as a total fulfilment of WiDom’s obligations.

Warranty exclusion

- defects caused by normal wear of parts or especially subject to wear, such as parts that require periodic replacement during the normal operation of the system (eg. Batteries);

- splits, cracks, scratches, dents, scratched or discolored surfaces and parts, breakage of plastic parts and in general of any other cosmetic damage;
- damages resulting from use of the system other than that provided, including but not limited to the failure to follow instructions contained in the operating manual;
- damages caused by accident, abuse, misuse, dirt, viruses, liquid contact, fire, earthquake, improper or inadequate maintenance or calibration, negligence or other external causes;
- environmental damage and / or defects caused by smoke, dust, dirt, soot, or other external influences;
- damages caused by modifications and alterations in the functionality or features without the written permission of WiDom;
- damages resulting from transportation or inadequate packaging when returning the product to a WiDom or to an authorize service center;
- defects caused by force majeure events such as lightning, floods, fires, incorrect voltage, improper ventilation;
- damages caused by malfunctioning software, computer virus attack, or by failure to update the software as recommended by WiDom;
- damages resulting from surges in the power and/or telecommunication network, improper connection to the grid in a manner inconsistent with the operating manual, or from connecting other devices not recommended by WiDom;
- damages caused by operating or storing the device in extremely adverse conditions, i.e. high humidity, dust, too low (freezing) or too high ambient temperature;
- products whose serial number has been removed, damaged or rendered illegible;
- expiration of the Warranty Period.

If a defect is not covered by the Warranty, WiDom will inform the Customer about the extra expenses for the repair or replacement.

This warranty may be subject to changes. Please check at: www.widom.it the newest warranty claim procedure.

This guarantee shall not exclude, limit or suspend the Customer rights when the provided product is inconsistent with the purchase agreement.

© All rights reserved. WiDom is a trademark of WiDom srl. All other brand names, product names, or trademarks belong to their respective owners. WiDom reserves the right to change product features and specifications at any time without notice, and is not responsible for typographical or graphical errors that may appear in this document.

Please check at: www.widom.it the newest version of this document.

Printed in Italy on low-impact recyclable paper.